



## USER MANUAL

NXACEN160C • 01/2022



**OWANDY-RX<sup>AC</sup>**

PRECISION AND SIMPLICITY

AC INTRAORAL RADIOLOGY SYSTEM

Language of the original document: ENGLISH

**Important: All new editions and revisions of the manuals supersede the previous ones**



Refer to complete manuals and instructions



For complete manuals and instructions  
[www.owandy.com](http://www.owandy.com)



Scan the QR code to access the dedicated website  
[www.owandy.com](http://www.owandy.com)

**MANUFACTURER**

**Owandy Radiology**

2 rue des vieilles vignes  
77183 Croissy-Beaubourg  
FRANCE

Tel. +33 1 64 11 18 18

**info@owandy.com**  
**www.owandy.com**

THE RADIOGRAPHIC SYSTEM DESCRIBED IN THIS MANUAL REFERS BOTH TO THE WALL INSTALLATION AND THE MOBILE VERSION.

“OWANDY RADIOLOGY” RESERVES ITSELF THE RIGHT TO MODIFY THE PRODUCTION AND THE MANUAL WITHOUT NOTICE.

IT IS PROHIBITED TO MODIFY, COPY, REPRODUCE, DISPLAY, SHARE, DISCLOSE AND PUBLISH THIS MANUAL AND ALL OTHER DOCUMENTS REFERRING TO OWANDY-RX AC IN ANY FORM WITHOUT PRIOR WRITTEN CONSENT BY OWANDY RADIOLOGY.

THE MANUAL MUST ALWAYS BE KEPT NEAR THE MEDICAL DEVICE FOR FUTURE REFERENCE.

OWANDY RADIOLOGY SHALL NOT BE LIABLE FOR AN INCORRECT USE OF THE INFORMATION CONTAINED IN THIS MANUAL.

# SOMMAIRE

<b>CONTROL PANEL .....</b>	<b>6</b>
<b>PRELIMINARY INFORMATION .....</b>	<b>7</b>
1.1. PRELIMINARY INFORMATION .....	7
1.2. INFORMATION FOR THE OPERATOR.....	7
1.3. QUALITY DETERMINANTS IN X-RAY INTRAORAL RADIOGRAPHY.....	8
1.4. WARRANTY CODITIONS.....	9
1.5. TRANSPORT CONDITIONS .....	9
1.6. SAFETY WARNINGS.....	9
<b>RADIOGRAPHIC SYSTEM .....</b>	<b>14</b>
2.1. RADIOGRAPHIC SYSTEM.....	14
2.2. SYSTEM COMPONENTS.....	15
2.2.1. ACCESSORIES .....	16
2.3. IDENTIFICATION TAGS .....	16
<b>CONFIGURATION.....</b>	<b>19</b>
3.1. CONFIGURATION.....	19
<b>INSTRUCTIONS FOR USE .....</b>	<b>21</b>
4.1. INSTRUCTIONS FOR USE .....	21
4.2. CONE REPLACEMENT .....	26
<b>EXPOSURE VALUES .....</b>	<b>27</b>
5.1. CHART OF DEFAULT EXPOSURE VALUES.....	27
<b>PROGRAMMING DEFAULT EXPOSURE VALUES.....</b>	<b>32</b>
6.1. PROGRAMMING DEFAULT EXPOSURE VALUES.....	32
6.2. RESTORING ORIGINAL VALUES .....	34
<b>DIAGNOSTIC.....</b>	<b>35</b>
7.1. DIAGNOSTIC.....	35
<b>CHAPTER 8 .....</b>	<b>36</b>
8.1. ERROR MESSAGES.....	36
<b>VERIFICATION OF THE EXPOSURE FACTORS .....</b>	<b>37</b>
9.1. VERIFICATION OF THE EXPOSURE FACTORS .....	37
<b>SUGGESTED MAINTENANCE .....</b>	<b>39</b>
10.1. SUGGESTED MAINTENANCE .....	39
10.2. CLEANING THE OUTER SURFACES.....	39
<b>REPAIR .....</b>	<b>41</b>
11.1. REPAIR.....	41
11.2. DISPOSAL.....	41
<b>ANNEX 1 .....</b>	<b>42</b>
A1. TECHNICAL SPECIFICATIONS .....	42
<b>ANNEX 2 .....</b>	<b>46</b>
A2. INTENDED ENVIRONMENT.....	46
<b>ANNEX 3 .....</b>	<b>47</b>
A3. LIST OF INTERNATIONAL STANDARDS AND DIRECTIVES.....	47
<b>ANNEX 4 .....</b>	<b>48</b>
A4. DOSIMETRIC INDICATIONS.....	48
<b>ANNEX 5 .....</b>	<b>49</b>
A5. ELECTROMAGNETIC COMPATIBILITY.....	49
<b>ANNEX 6 .....</b>	<b>53</b>
A6. DRAWINGS AND DIMENSIONS .....	53
<b>ANNEX 7 .....</b>	<b>55</b>
A7. INSTALLATION ELECTRICAL SCHEME.....	55

# CONTROL PANEL

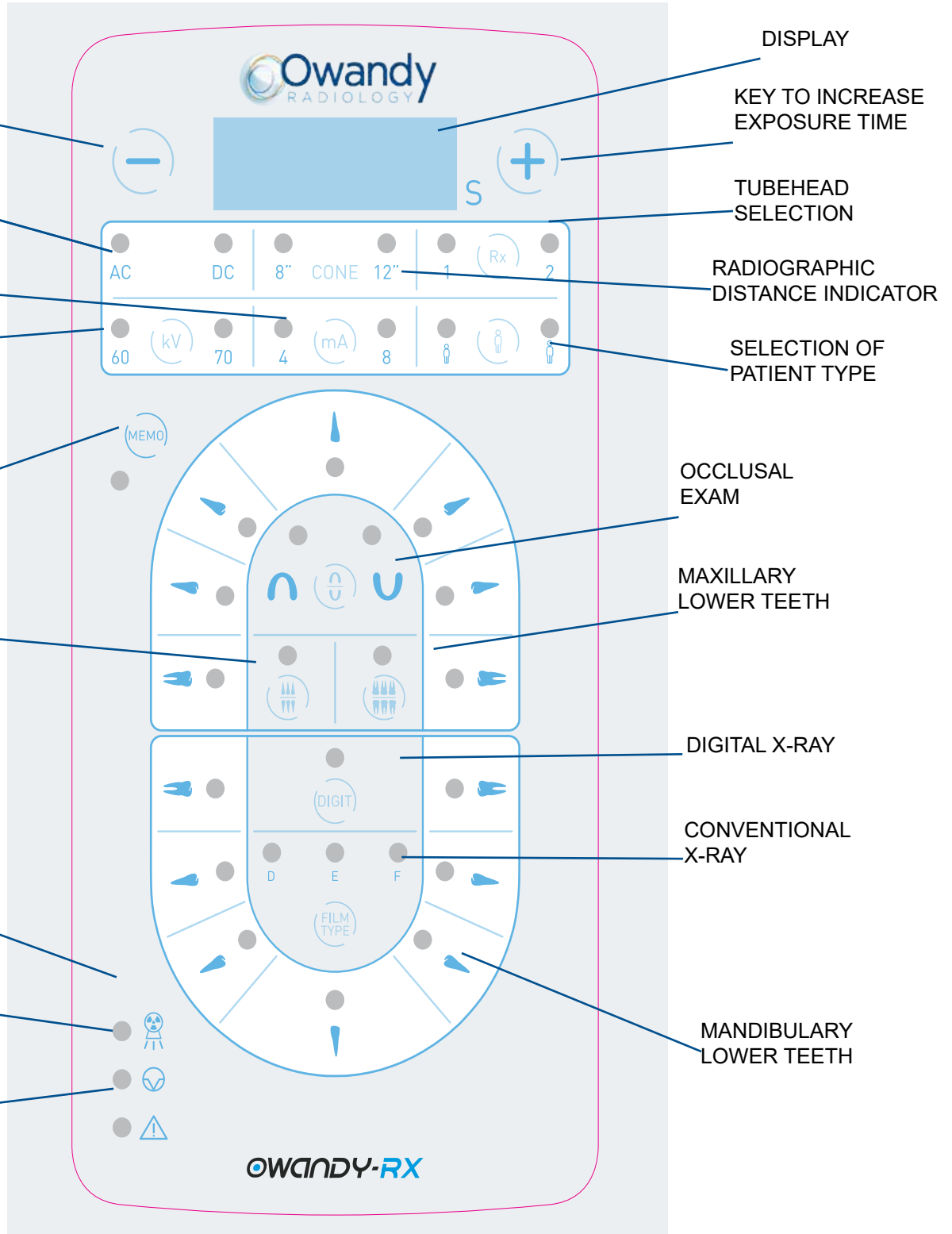

# 1

## PRELIMINARY INFORMATION

### 1.1. PRELIMINARY INFORMATION

Before beginning to use the Owandy-RX AC radiographic system, it is mandatory to carefully read and follow the instructions contained herein, so as to obtain the best possible performance and to assure the safety of the patient, operator, device and environment.

Always pay close attention to the  
**CAUTION**  
**WARNING**  
**PLEASE NOTE**  
 messages when operating the system.

#### **LEGEND**

##### **⚠ CAUTION**

*The word **CAUTION** identifies those occurrences which might compromise the operator's personal safety or cause injuries to people.*

##### **⚠ WARNING**

*The word **WARNING** identifies those occurrences which might compromise the radiographic system's performance.*

##### **📄 PLEASE NOTE**

***PLEASE NOTE** serve to give special indications so as to facilitate maintenance or make important information clearer.*

### 1.2. INFORMATION FOR THE OPERATOR

Dear Customer,

thanks for having chosen the **Owandy-RX AC** radiographic system.

It is designed and manufactured by *Owandy Radiology* and is the result of many years of experience in the field of radiology and in the application of advanced electronics.

This high performing system represents a further development of technological research at the service of dental radiography.

The **Owandy-RX AC** is an X-ray generator for dental intra-oral X-ray imaging, particularly, **Owandy-RX AC** is an extra-oral source of X-rays, intended to be used for producing diagnostic dental radiographs for treatment of disease of teeth, jaw and oral structures.

From a clinical point of view, **Owandy-RX AC** can be applied in routine dental radiography examinations involving the diagnosis, treatment, i.e. surgical or interventional, of disease of the teeth, jaw and oral cavity structures.

Its intended medical applications are:

- Generic dentistry
- Dental implantology
- Dental surgery

The intended population can be whatever, anyway the sustainability of the X-ray exposure must be evaluated by surgeons, dentists and qualified and authorized physicians.

The Intended user profile is an able-bodied specialized surgeon, dentist and authorized personnel, who meet the requirements provided by the national laws in force in the country of installation; they must understand the language of

the country where the device is installed. The intended conditions of use are detailed in Annex A2 (“Intended Environment”).

#### PLEASE NOTE

*This manual does not contain all the recommendations and the obligations relative to the possession of a source of ionising radiations – since they do vary from Country to Country – but only the most common ones.  
The user must consult his country's legislation so as to fulfil all local obligations.*

#### WARNING

*This manual describes how to set and use the **Owandy-RX AC** X-ray system.  
The operator must read and understand the manual before using the medical device.  
This manual must be always kept as a reference document.  
Before using this device for the first time, it is essential to thoroughly and carefully read the instructions, CAUTION and WARNING messages listed in the present chapter.  
It is mandatory to comply with these instructions every time the device is used.  
**Owandy-RX AC** is compatible with all kind of X-ray detectors which have been designed and certified for dental intra-oral radiology; in detail, such a compatibility is ensured by the compliance of the **Owandy-RX AC** device with the basic safety and essential performance requirements of the IEC 60601-2-65: 2012.*

### 1.3. QUALITY DETERMINANTS IN X-RAY INTRAORAL RADIOGRAPHY

Image quality is linked to the precise and accurate acquisition of information from the X-ray beam transmitted through the patient (i.e., the X-ray detector). Most problems in dental radiography are not the result of X-ray equipment failure: the production of consistent and high quality X-ray diagnostic images, concurrent with minimal patient exposure, depends generally on different components: quality performance of equipment, characteristics of the modules used which affect the imaging system resolution (i.e.: X-ray image detector type and relevant image processing chain, analogue or digital) and optimal performance of the operator.

Among the physical factors for achieving optimum image quality, the following can be considered:

- optimum optical density and Wiener spectrum,
- detectors for radiography must meet the needs of the specific radiological procedure where they will be used and key parameters are spatial resolution, uniformity of response, contrast sensitivity, dynamic range, acquisition speed and frame rate
- minimization of motion blurring (using short exposure times),
- minimization of geometric blurring (reducing the focal spot size and/or of the object-film distance),
- geometric distortions,
- correct positioning: errors in patient positioning when using uncoupled positioning devices during the various typologies of X-ray examinations may lead to exposure errors, which require additional X-ray exposures, thereby increasing the radiation dose adsorbed by the patient.

This means that it is absolutely essential and mandatory that the operator consider the performances not only of the **Owandy-RX AC** equipment itself, but the whole chain of components that bring to the final X-ray diagnostic image. The essential parameters and relevant metrics which describe the performance of dental X-ray system, with regard to imaging properties and patient dose, methods of testing and whether measured quantities related to those parameters comply with the specified tolerances, are stated by the respective manufacturers and by the requirements specified by the respective applicable standards.

Radiographic films, film processing, digital X-ray image detectors, and imaging plates are vital parts in the imaging chain. It is responsibility of the operator to ensure that these components perform in an acceptable way, with respect to sensitivity, contrast and absence of artifacts. A test of the performance of these components shall precede any acceptance test measurement involving the irradiation of the X-ray detectors using the **Owandy-RX AC**.



## ⚠ WARNING

*It is full responsibility of the operator and RESPONSIBLE ORGANIZATIONS of the **Owandy-RX AC** to check that any kind of X-ray detectors used with the **Owandy-RX AC** are in compliance with the requirements stated by their specific regulations in force and to the specifications stated by their respective manufacturers.*

## 1.4. WARRANTY CODITIONS

Inappropriate use or any arbitrary tampering with the equipment exempt *Owandy Radiology*, as manufacturer of the **Owandy-RX AC** radiographic system, from any service under warranty or from any other liability.

The warranty is valid only if the following precautions are taken:

- any repairs, modifications, adjustments, recalibrations must be performed only by *Owandy Radiology*
  - the installation must be made by professionally qualified technicians according to the regulations in force
  - the system must be installed and used in compliance with the instructions given in this Manual and for the purposes and applications for which it was designed
  - the power supply must be adequate to supply the required power indicated in the radiographic system's nameplate data
  - in order to safeguard one's warranty rights, please fill in the enclosed Warranty Document, immediately after the installation is completed, together with the technician
  - The system must be checked completely at least each 12 months by professionally qualified technicians according to the regulation in force. Use the manuals provided with the device **Owandy-RX AC** for reference.
  - In case of repair, please use only spare parts from the manufacturer of the **Owandy-RX AC**.
- Otherwise basic safety and essential performances of the device will not be guaranteed.

***Owandy Radiology* is not responsible for any damage caused by any person or thing as a consequence of non-compliance of any of the guidelines contained in all the manuals provided with the **Owandy-RX AC** device.**

## ⚠ CAUTION

*No compliance of any of the above mentioned rules and all the indications provided by the manufacturer in the documentation, or successively in written paper or electronic format, will result in losing the warranty of the product and the manufacturer will be discharged from any obligation, including consequential damages, direct or indirect that may derive to people, things or environment. Furthermore, the facility representative, customer or employees of the facility, will be liable for any damage and/or incident and/or degeneration of the health status of a patient, operator, involved people and the surrounding environment.*

## 1.5. TRANSPORT CONDITIONS

### **The **Owandy-RX AC** radiographic system travels at the receiver's own risk.**

All claims for damage or miscarriage regarding the shipment must be pointed out in the presence of the shipping agent.

In case of miscarriages, or actual or suspected damage, the receiver shall indicate the proper reserves on the way-bill or on the consignment note.

## 1.6. SAFETY WARNINGS

A few safety recommendations which should be followed when using the **Owandy-RX AC** radiographic system are listed here below.

**⚠ CAUTION****GENERAL REQUIREMENTS**

*RESPONSIBLE ORGANIZATION is the authority that has the responsibility for the USE and MAINTENANCE of the Owandy-RX AC radiographic system.*

*Training and preparation of personnel is responsibility of THE RESPONSIBLE ORGANIZATION.*

*Owandy-RX AC radiographic system is an X-ray generator and must be used and handled only by specialised surgeons, dentists and authorized personnel, who meet the requirements provided by the national laws in force in the country of installation.*

*It is mandatory for the RESPONSIBLE ORGANIZATION to provide a routine and special maintenance schedule for medical equipment; this schedule must be documented for every device and transmitted to the various operating levels (\*). The preventive maintenance (that must be performed at least every 12 months), which includes functional, performance and safety tests of the device, must be carried out by qualified, authorized professional technicians. It is mandatory to ensure patients' health and safety and proper Owandy-RX AC radiographic system operation (IEC 60601-1 etc.). These operations must be carried out according to the methods and frequency indicated in this manual and in the installation and maintenance manual. Failure to comply with this requirement or with the messages concerning anomalies will release the manufacturer from any liability for direct and indirect injuries to persons and/or damage to property or the environment. Furthermore, the managers of the facility, customers or collaborators will be held liable for any damage and/or accidents and/or degeneration of patients' or operators' health or of the surrounding environment.*

*The RESPONSIBLE ORGANIZATION must also provide for the safe and proper use of the equipment.*

*(\*) For Italy refer to Presidential Decree 14/01/1997, Legislative Decree No. 81/2008 (as subsequently amended and modified).*

*Operators must know the environmental and operating specifications of the device, as well as the procedures to follow in the event of hazards or emergency stops.*

*Owandy-RX AC radiographic system has been designed to acquire radiography images for dental intraoral X-ray imaging. The Owandy-RX AC medical device must not be used for X-ray imaging of other body parts.*

*Carefully follow the instructions of this manual to install, operate and maintain the Owandy-RX AC radiographic system. In the event that local laws and standards are more restrictive than the manufacturer's indications, the former supersede the latter.*

*The RESPONSIBLE ORGANIZATION must comply with the standards and regulations in force concerning the installation of the medical device in consideration of the place of installation.*

*The operator is cautioned to monitor the patient and the parameters of the Owandy-RX AC radiographic system throughout the entire duration of the X-ray examination.*

*It is prohibited to modify any part of the Owandy-RX AC medical device.*

*Owandy Radiology and its authorized technicians are not required to verify compliance of the installation site with local standards concerning electrical safety and X-ray protection and with any other directive concerning safety in force in the country of installation.*

*The RESPONSIBLE ORGANIZATIONS of the facility must ensure compliance of the installation site with the local laws in force.*

*Before each examination, it is mandatory to apply to the collimator cone (Beam Limiting Device) a disposable protection sheath designed to cover the end part of the X-ray unit, which is more susceptible of being directly contaminated during the X-ray exposure (class I Medical Device Directive 93/42/EEC and subsequent amendments). It can come into contact with the patient's skin: verify biocompatibility according to the principles given in the ISO 10993 series of standards, refer for details to the disposable use protection's instructions for use.*

*Before operating the Owandy-RX AC radiographic system you must assure that the device has no visible signs of damage.*

**⚠ CAUTION****PROTECTION AGAINST RADIATIONS**

*“The general principles regarding safety and protection of workers and people” must always be applied when using the unit:*

- 1. Justification of the practice*
- 2. Protection Optimisation*
- 3. Reduction of the limits of individual dose and risks*

*The Owandy-RX AC is a medical device that generates X-rays; therefore, both the patients and the operator are exposed to risks due to ionizing radiation. The physician must assess the actual need for X-ray exposure.*

*All personnel present during an X-ray examination must comply with safety regulations concerning protection against radiation. For their own safety, the operator must always keep a distance of more than 2 meters (6 ft.) and out of the path of the X-ray beam, in order to avoid the exposure to the stray radiation.*

*The Owandy-RX AC medical device must be used in compliance with the local standards in force and with the international directives concerning radiation protection.*

*The device must comply with the guidelines and indications provided by an accredited specialist in radiation protection, who will recommend, if necessary, additional shields or precautions for every specific case.*

*The device installation site must be shielded in compliance with the local standards in force to protect the operator, patient and other people against X-rays.*

*The Owandy-RX AC device is intended to be used solely by surgeons, dentists and qualified and authorized physicians. The operator must:*  
*- determine, when appropriate, the possible need for sedation and the related operating methods and appropriate precautions for the patient*  
*- supervise the entire X-ray examination procedure, paying attention to the indications and information from the unit.*

*The device must be used only for diagnostic purposes by qualified and authorized dentists and/or physicians.*

*The operator and other personnel must keep clear from the patient during the scan.*

*The personnel involved in the radiographic examination must take all the safety measures concerning radiation protection.*

*It is the operator's responsibility to protect the patient against unnecessary or excessive radiation doses.*

*Additional protection devices (aprons, collars, etc) are required to protect the patient from radiation.*

*Before exposing patients with pacemakers, contact the manufacturer of the latter to ensure that the X-rays generated by Owandy-RX AC do not interfere with its functionality.*

*Owandy-RX AC generates X-rays: before using this X-ray system please refer to the regulation in force in your area concerning paediatric patients, pregnant women and anyone with health issues that contraindicate the use of X-rays. Investigate and make sure of this condition before starting the exposure.*



*This symbol indicates X-ray hazard.*

**⚠ CAUTION****MECHANICAL RISK**

*Before removing the tubehead from the positioning arm, RELEASE THE SPRING.  
The sudden opening of the joint may cause damage to people and/or things.*

*Check that the installation of the unit complies with the mechanical specifications of the support (walls, ceiling, etc..) where it is installed.*

*Adjustments or any kind of attempt of repairing or disassembling must only be performed by qualified and authorized service personnel.*

*The Owandy-RX AC must not be used in environments or close to environments subjected to mechanical vibrations or mechanical shocks.*

**⚠ CAUTION****ELECTRIC SAFETY**

*The radiographic system contains high voltage. It is prohibited to inspect internal parts of the system.*

*Never attempt to open the X-ray tubehead.*

*The covers on the Owandy-RX AC radiographic system must only be removed by qualified and authorized service personnel.*

*The unit must be used only in environments that are in compliance with all electrical safety standards set forth for medical environments.*

*To avoid the risk of electric shock, this device must only be connected to a supply mains with protective earth.*

*The unit is NOT equipped with protections against penetration of liquids; it will therefore be necessary to make sure that no water or other liquids penetrate inside in order to avoid short circuits or corrosion.*

*Always disconnect the radiographic system from the power supply and wait for 2 minutes before beginning cleaning and disinfecting operations.*

*Do not connect the X-ray system to a multiple portable socket outlet (MPSO) nor to any type of extension cord.*

*External equipment intended for connection to signal input, signal output or other connectors shall comply with the relevant product standard e.g. IEC 60950-1 for IT equipment and the IEC 60601-series for medical electrical equipment. In addition, all such combinations – systems – shall comply with the safety requirements stated in the standard IEC 60601-1, edition 3, clause 16. Any equipment not complying with the leakage current requirements in IEC 60601-1 shall be kept outside the patient environment i.e. at least 1.5 m from the patient support.*

*It is mandatory to use an isolation device (Separation Device) to isolate the equipment located outside the patient environment from the equipment located inside the patient environment. In particular such a Separation Device is required when a network or data connection is made. The requirements on the Separation Device is defined in IEC 60601-1, edition 3, clause 16.*

*For the wall version of Owandy-RX AC:*

*based on the IEC 60601-1, the installation is a permanent type (fixed). IT IS NOT ALLOWED TO connect the equipment to the main supply using a plug.*

*The cone (beam limiting device) is an APPLIED PART of the system and it is classified as type B.*

**⚠ CAUTION****EMC COMPATIBILITY**

*EMC requirements must be considered and the Owandy-RX AC must be installed and used accordingly with the specific EMC information provided in the accompanying documents.*

*The device complies with the EMC (Electromagnetic Compatibility) requirements, according to IEC 60601- 1-2. Radio transmitting equipment, cellular phones etc. shall not be used in close proximity of the unit as they could influence the performance of the system.*

*Carefully read the indications relevant to the EMC in the dedicated appendix A5. EMC compatibility of this manual.*

*Repairs and replacements of any component included cables, must be carried out solely by authorized and highly qualified personnel and only using genuine spare parts supplied by Owandy Radiology. Using other cables may negatively affect EMC performance.*

**⚠ CAUTION****PROTECTION AGAINST EXPLOSIONS**

*The radiographic system MUST NOT be used in the presence of disinfectant, flammable or potentially explosive gases or vapours that might catch fire and cause damage.*

*In case these disinfectants have to be used, let the vapour completely disperse before turning on the radiographic system.*

**⚠ CAUTION****SYSTEM MODIFICATIONS OR UPGRADES**

*Modifications or upgrades of the system can be carried out only if advised by Owandy Radiology and performed by authorized and qualified personnel, using ONLY genuine original spare parts of Owandy Radiology.*

*Owandy Radiology proscribes improper, unauthorized modifications or upgrades of the device, in order to avoid malfunctions resulting in breakdowns and/or accident for patient, operator and equipment. Owandy Radiology assumes no responsibility and, consequently, declines all responsibility with respect to direct or indirect damages to people, the device or environment due to these reasons.*

*Do not remove or attempt to remove the plastic covers of the device.*

*It is strictly forbidden to attempt to repair electronic or mechanical parts by yourself.*

*Disregarding this warning can result in irreversibly compromising the overall safety of the system and can be dangerous for operators, patients and environment.*

# 2

# RADIOGRAPHIC SYSTEM

## 2.1. RADIOGRAPHIC SYSTEM

The Owandy-RX AC radiographic system guarantees the maximum safety both for the operator and the patient.

It is built in compliance with the following European Directives:

▶ 93/42/EEC and subsequent amendments MEDICAL DEVICES

▶ EURATOM 96/29 IONISING RADIATIONS

The following protective measures were adopted in the design and construction of the unit:

- protection against the risk of electric injuries, ensured by a grounded protection conductor;
- protection against leakage radiation, made negligible by the shielded casing;
- protection against excessive radiations, thanks to the immediate activation of the safety device;
- protection against continuous service, since the system is designed, according to standards, not to allow use in radioscopy;
- protection for the patient against dangerous radiations, obtained by means of the high frequency technology capable of producing a constant and hard radiation;
- protection against exposure mistakes obtained with the high frequency technology which is unaffected by voltage fluctuation and consequently capable to guarantee extremely accurate exposure parameters;
- protection for the operator against irradiation ensured by the extensible cable of the hand control which allows for a safety distance of more than 2 meters (6 ft.);
- protection against involuntarily selection of radiographic technique (FILM or DIGIT) obtained, according to standards, by means of confirmation on the selection key.

### “ELECTRO-MEDICAL” CLASSIFICATION

According to paragraph §6 of the general safety regulations CEI EN 60601-1: 2007 on safety of medical equipment, the system is classified as: **Class I - Type B**

### “MEDICAL DEVICES” CLASSIFICATION

According to the classification rules indicated in attachment IX of the EEC Directive 93/42 on medical devices and subsequent amendments the system is classified as: **Class IIb**

### “E.M.C.” CLASSIFICATION

According to paragraph §4 of the CEI EN 55011, the system is classified as: **Group 1 – Class B**

## 2.2. SYSTEM COMPONENTS

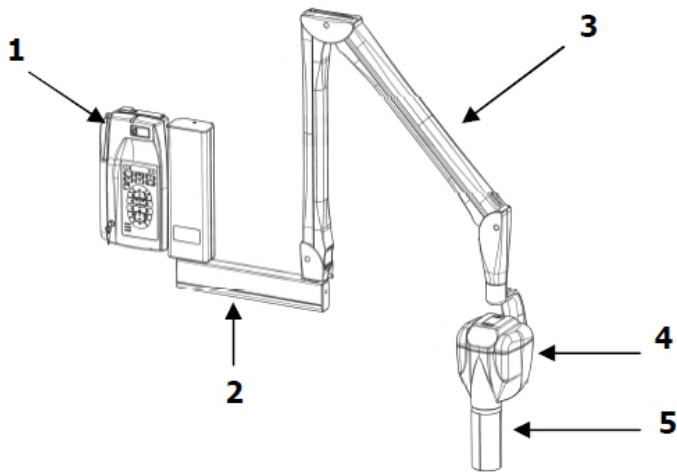

Fig. 1

**Owandy-RX AC** radiographic system (Fig. 1) consists of:

### 1. Owandy-RX AC TIMER

The timer is the control panel used to manage the exposure times and to safely use the tubehead.

To make the exposure, the control button with safety key is available.

The timer can be connected to n° 2 ac tubeheads.

In case of alternate current tubeheads the technology of the timer is “self - compensating”:

depending on the line voltage fluctuation, the microprocessor automatically modifies the predetermined exposure time ensuring a constant dose to the patient.

This technological expedient avoids the repetition of the exposure because of over/under exposure errors.

### 2. BRACKET

The horizontal bracket is available in 3 different lengths (110 cm, 80 cm, 40 cm) and represents the support for the pantograph arm. Its shaft is fixed in a dedicated section of the timer (top or bottom) and allows for 180° movement.

### 3. PANTOGRAPH ARM

Thanks to the new shape and new mechanisms of the positioning arm, it can be adjusted in height and depth in order to precisely explore any spot in its reach.

It is made of light alloy with an ABS coating.

### 4. Owandy-RX AC TUBEHEAD

The intra-oral tubehead Owandy-RX AC is a monoblock type and its light alloy housing contains an airtight compartment. The high voltage transformer, the X-ray tube and the expansion chamber are submerged in highly dielectric insulating oil inside a light alloy container.

The expansion chamber guarantees an adequate compensation to oil expansion for the entire temperature range.

The X-ray tube is located in the back part of the container, allowing a source-skin distance 50% higher than traditional structures.

### 5. CONE

The collimator cone or Beam Limiting Device represents the applied part of the device. Made of transparent polycarbonate, or alternatively of lead-coated polycarbonate, it ensures:



- the correct distance between focal spot and skin
- dimension, direction and centering of X-ray beam
- the realization of different radiographic technique (biting and parallel technique).

During X-ray exposition, the collimator cone comes in contact with the skin of the patient.

Before each exam, it is necessary to apply to the cone a disposable protective cover designed to cover the end part of the X-ray generator.

Such protection is useful to avoid crosscontamination (from patient to patient).

### 2.2.1. ACCESSORIES

<p><u>ECB: remote exposure switch</u></p> 	<p>The intraoral accessories ECB (External Command Button) allows to mount the timer close to the arm+head (inside the room), having the External Command Button outside the room.</p>
<p><u>External Lights</u> <u>100-240 V</u></p> 	<p>Lights supplied for highlighting the XRay emission outside the XRay room. (Also not using this accessory, the same function can be achieved by the final user with a different light connected to the equipment)</p>
<p><u>MOBILE STAND</u> <u>UK PLUG.COL RAL9003</u></p> 	<p>Mobile configuration of Owandy-RX AC is the third possible configuration (besides the two standards wall mounting, top or bottom). The mobile stand provides the possibility to move Owandy-RX AC quickly and easily to different position of the room. The stand consists of supporting structure, handle and four castors. This accessory is provided with the UK plug.</p>

**⚠ CAUTION**

*Using other accessories may negatively affect EMC performance*

### 2.3. IDENTIFICATION TAGS

The identification tags on the tubehead, on the timer and on the cone indicate the model number, the serial number, the manufacturing date and the main technical characteristics.

#### 2.3.1. TUBEHEAD

Model 230 V

Model 220 V

<b>Owandy RX-AC</b> x-ray source		
OWANDYRADIOLOGY SAS 2, rue des Vieilles Vignes 77183 Croissy-Beauborg - FRANCE		<b>0051</b>
Output max.: 70kV 8mA Total filtration: 2,3 mm Al/ 70KV X-ray tube:	Nominal voltage: 220 V - 50/60Hz Class I	 

<b>Owandy RX-AC</b> x-ray source		
OWANDYRADIOLOGY SAS 2, rue des Vieilles Vignes 77183 Croissy-Beauborg - FRANCE		<b>0051</b>
Output max.: 70kV 8mA Total filtration: 2,3 mm Al/ 70KV X-ray tube:	Nominal voltage: 230 V - 50/60Hz Class I	 



Model 115 V

<b>Owandy RX-AC</b> x-ray source		<b>Owandy</b> RADIOLOGY	
OWANDY RADIOLOGY SAS 2, rue des Vieilles Vignes 77183 Croissy-Beauborg - FRANCE			<b>CE</b> 0051
Output max.: 70kV 8mA Total filtration: 2,3 mm Al/ 70KV X-ray tube:	Nominal voltage: 115 V - 50/60Hz Class I		0.7 mm IEC 60336

2.3.2. TIMER

Model 230 V

<b>Owandy RX-AC</b> x-ray control unit		<b>Owandy</b> RADIOLOGY	
OWANDY RADIOLOGY SAS 2, rue des Vieilles Vignes 77183 Croissy-Beauborg - FRANCE			<b>CE</b> 0051
Rated line voltage: 230 V - 50/60Hz Absorbed power: 0,8kVA	Class I	IP20	

Model 220 V

<b>Owandy RX-AC</b> x-ray control unit		<b>Owandy</b> RADIOLOGY	
OWANDY RADIOLOGY SAS 2, rue des Vieilles Vignes 77183 Croissy-Beauborg - FRANCE			<b>CE</b> 0051
Rated line voltage: 220 V - 50/60Hz Absorbed power: 0,79kVA	Class I	IP20	

Model 115 V

<b>Owandy RX-AC</b> x-ray control unit		<b>Owandy</b> RADIOLOGY	
OWANDY RADIOLOGY SAS 2, rue des Vieilles Vignes 77183 Croissy-Beauborg - FRANCE			<b>CE</b> 0051
Rated line voltage: 115 V - 50/60Hz Absorbed power: 0,66kVA	Class I	IP20	













CONE

	OWANDY RADIOLOGY SAS 2, rue des Vieilles Vignes 77183 Croissy-Beauborg - FRANCE	Beam limiting device type Effective Beam at cone Tip		
--	---	---	--	--

GRADUATED SCALE



PICTOGRAMS USED

	<p>SYMBOL INDICATING THE MANUFACTURER</p>
	<p>THIS SYMBOL GUARANTEES THAT THE RADIOGRAPHIC SYSTEM COMPLIES WITH THE REGULATIONS CONTAINED IN THE EUROPEAN DIRECTIVE EEC 93/42 REGARDING MEDICAL DEVICES</p>
	<p>SIZE OF THE FOCAL SPOT</p>
	<p>THE DEGREE OF PROTECTION AGAINST DIRECT AND INDIRECT ELECTRIC CONTACTS IS B TYPE</p>
	<p>SYMBOL INDICATING THE SERIAL NUMBER</p>
	<p>SYMBOL INDICATING DANGER DUE TO IONISING RADIATIONS</p>
	<p>X-ray EMISSION (IEC 60417)</p>
	<p>PAUSE (IEC 60417)</p>
	<p>ATTENTION, REFER TO THE ATTACHED DOCUMENTS</p>
	<p>INSTRUCTIONS IN ELECTRONIC FORMAT</p>
	<p>REFER TO MANUAL'S INSTRUCTIONS</p>
	<p>WEEE (Waste Electrical and Electronic Equipment) SYMBOL, IN CONFORMITY WITH 2012/19/CE DIRECTIVE AND EN 50419 STANDARD.</p>

# 3

## CONFIGURATION

### 3.1. CONFIGURATION

The **Owandy-RX AC** radiographic system is provided in the “standard mode” configuration.

On the control panel the LED relevant to the following exposure parameters will light up:

	No. of the selected tubehead LED 1
	supplied cone LED 8” = SHORT CONE LED 12” = LONG CONE
	Type of tubehead LED AC = ALTERNATE CURRENT
	radiographic voltage LED 70kV
	radiographic current LED 8mA
	type of patient LED ADULT
	radiographic technique CONVENTIONAL LED D

The following exposure times (s) have been stored:

0,080 – 0,100 – 0,125 – 0,160 – 0,200 – 0,250 – 0,320 – 0,400 – 0,500 – 0,630 – 0,800 – 1,00 – 1,250 – 1,600 – 2,000 – 2,500 – 3,200

**PLEASE NOTE**

*These times are in compliance with current CEI EN 60601-1: 2007 standard and with the ISO 497 series R'10 recommendations.*  
**THEY CANNOT BE MODIFIED**

Certain exposure values which depend on the selection of the operating parameters have been predefined:

- ▶ cone (8"/12")
- ▶ type of patient (ADULT/CHILD)
- ▶ radiographic technique
- ▶ intra-oral test

 **PLEASE NOTE**

*These values have to be considered as "recommended": it is possible to change these values if necessary. (refer to Charter 5 and 6)*

To modify these exposure values

- ▶ Type of patient (ADULT/CHILD)
  - ▶ Radiographic technique
- (refer to Chapter 4)

To modify these exposure values

- ▶ N° of tubehead (1/2)
- ▶ Type of tubehead (AC/DC)
- ▶ N° control button
- ▶ Type of cone (8" /12")

change the dip-switch position, inside the timer

**THIS OPERATION MUST BE CARRIED OUT BY THE INSTALLER ONLY**

# 4

## INSTRUCTIONS FOR USE

### 4.1. INSTRUCTIONS FOR USE

#### 1° - TURN ON

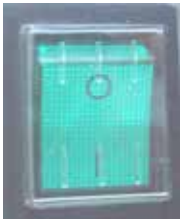

Bring the main switch located on the upper part of the timer to the “I” position (ON)

1. the green light turns on, indicating that the system is powered
2. the LEDs of the set parameters automatically light up
3. the exposure time is shown on the display

#### **⚠ CAUTION**

*If an error is detected when the system is turned on, please refer to Chapter 8 ERROR MESSAGES of this Manual*

#### **📄 PLEASE NOTE**

*The exposure time and parameters which appear on the display are the last that were set before the timer was turned off. If the timer remains inactive for a few minutes, it switches to the stand-by mode. Press any key on the control panel to restore it to the operative mode.*

#### 2° - CHECK THE SELECTED PARAMETER

Before making the exposure, check that the parameter selected on the control panel (from Step 1 to Step 8) are suitable for the radiographic exam.

##### STEP 1 : check the selected tubehead

The LED of the desired tubehead should be turned on



##### **LED Rx 1 ON**

indicates that the tubehead connected to the timer X-ray1 terminal block is selected

##### **LED Rx 2 ON**

indicates that the tubehead connected to the timer X-ray2 terminal block is selected

to change the selection press again the button

**STEP 2 : check the selected radiographic distance CONE**

The LED of the cone length (source-skin distance = SSD) in use should be turned on

**LED 8" ON**

indicates that the selected tubehead is equipped with 8" = 20cm (SSD) cone

**LED 12" ON**

indicates that the selected tubehead is equipped with 12" = 31cm (SSD) cone

to change the selection call the "Assistance Service"

** PLEASE NOTE**

*After the modification, default exposure values will be automatically changed.*

**STEP 3 : check the selected type of tubehead**

The LED of the type of selected tubehead should be turned on

**LED AC ON**

indicates that the selected tubehead works in alternate current technology

**LED DC ON**

indicates that the selected tubehead works in direct current technology

It is not possible to change the selection: an ac device has to be used only in combination with an ac tubehead

**STEP 4 : check the selected radiographic voltage**

The LED of the radiographic voltage should be turned on

**LED 70kV ON**

if LED is not lit call the "Assistance Service"

**STEP 5 : check the selected radiographic current**

The LED of the radiographic current should be turned on



**LED 8mA ON**

if LED is not lit call the “Assistance Service”

**STEP 6 : check the selected type of patient**

The LED of the desired type of patient should be turned on



**LED CHILD ON**

indicates that the radiographic system is set for a patient with a small physique

**LED ADULT ON**

indicates that the radiographic system is set for a patient with a large physique

to change the selection press again the button



**PLEASE NOTE**

*After the modification, default exposure values will be automatically changed.*

**STEP 7 : check the selected radiographic technique**

**CONVENTIONAL TECHNIQUE (FILM)**

The LED of the desired speed film should be turned on

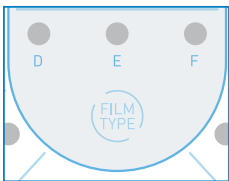

**LED D ON**

radiographic system is set for use with D speed film

**LED E ON**

radiographic system is set for use with E speed film

**LED F ON**

radiographic system is set for use with F speed film

to change the selection press the button for 3 s: an acoustic signal (beep) will confirm the change

**PLEASE NOTE**

After the modification, default exposure values will be automatically changed.

**DIGITAL TECHNIQUE (SENSOR)**

The LED should be turned on



to change the selection press the button for 3 s: an acoustic signal (beep) will confirm the change

**PLEASE NOTE**

After the modification, default exposure values will be automatically changed.

**STEP 8 : check the selected radiographic technique**

**PERIAPICAL EXAM**

The LED of the selected teeth should be turned on

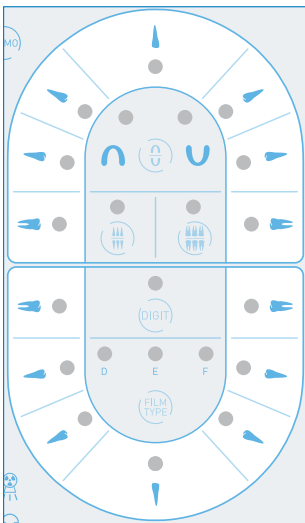

to change the selection press the key relative to the desired tooth

**OCCLUSAL EXAM**

The LED of the selected type of test should be turned on





**LED MANDIBULA ON**

radiographic system is set for occlusal exam of the lower jaw

**LED MAXILLA ON**

radiographic system is set for occlusal exam of the upper jaw

to change the selection press again the button

***BITE-WING EXAM***

The LED of the selected type of test should be turned on

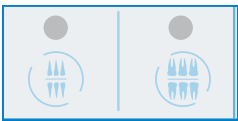

**LED ANT ON**

radiographic system is set for anterior bite-wing exam

**LED POST ON**

radiographic system is set for posterior bite-wing exam

to change the selection press the key relative to the desired exam

**3° - POSITIONING THE PATIENT**

Position the patient following the standard intraoral procedures.

**4° - POSITIONING FILM or SENSOR**

Position either the film or the digital sensor depending on the technique to be used.

**5° - POSITIONING CONE**

Follow the standard intra-oral procedures to position the cone.

**6° - CHECK ON THE DISPLAY THE SELECTED TIME**

Before proceeding with the exposure, check on the display the selected time

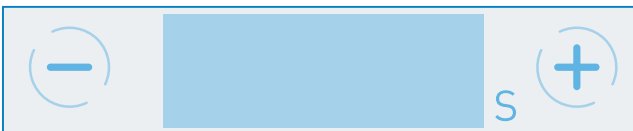

to change the selection press the following keys



**⚠ WARNING**

*This modification brought to the exposure time is momentary and it will be lost unless it is saved. (refer to Chapter 6) To restore the previous values, press one of the keys with the LED turned off on the control panel.*

**7° - MAKE THE EXPOSURE**

1. Take the control button of the timer relevant to the selected tubehead and keep a safety distance (at least 2 meters) from the tubehead, in order to be able to constantly check the radiographic exposure
2. Advise the patient to remain still
3. On the control button press the  X-ray key and keep it pressed until the acoustic signal (beep) stops and LED yellow turns off 

**PLEASE NOTE**

*If the “X-ray” key is released earlier than the selected exposition time, the exposure is immediately interrupted and the E12 error message appears on the display.*

4. At the end of the exposure, the green LED  PAUSE intermittently turns on
5. The display indicates the actual exposure time
6. All the timer functions are inhibited

**PLEASE NOTE**

The pause time is necessary to allow the X-ray tube to cool down.  
*This time is calculated by the microprocessor, depending on the exposure time, with a ratio of 1:32 (32 s of pause are required for each second of exposure)*

**A NEW EXPOSURE WILL BE POSSIBLE AFTER THE GREEN LED  HAS TURNED OFF**

**REPEAT THE OPERATIVE SEQUENCE FROM POINT 2 TO POINT 7 TO MAKE A NEW EXPOSURE**

**4.2. CONE REPLACEMENT**

1. Unlock the FIXATION screw using Allen key;
2. Remove the cone rotating it in anticlockwise direction;
3. Place the new cone rotating it in clockwise direction



**WARNING**

*Be sure to completely rotate it in clockwise direction.  
 IF ROTATION IS NOT COMPLETE OR IS DONE IN WRONG DIRECTION THE FIXATION BY SCREW SHALL NOT BE EFFECTIVE*

4. Lock the FIXATION screw using Allen key.

# 5 EXPOSURE VALUES

## 5.1. CHART OF DEFAULT EXPOSURE VALUES

The chart indicates the **Owandy-RX AC** radiographic system predefined exposure values. (refer to Chapter 3)

I	INCISOR
C	CANINE
P	PREMOLAR
M	MOLAR
Ba	ANTERIOR BITE-WING
Bp	POSTERIOR BITE-WING
Oa	OCCLUSAL ANTERIOR
Op	OCCLUSAL POSTERIOR

### PLEASE NOTE

*The default exposure times can be modified. (refer to Chapter 6)*

### PLEASE NOTE

*The following exposure values are only indicative and the manufacturer cannot guarantee the universal applicability of them for any kind of circumstances or type of X-ray sensor used, since variations and inaccuracies may arise from sensor to sensor and may require adjustments to accommodate local configurations (software, film processing, digital processing, CCD or CMOS types, etc.)*

*Therefore the operator must establish for each of support used and for each patient the correct technique factors (kV, mA, s) setting needed. The operator has the full responsibility to determine and implement the correct technique factors required in accordance with the type of X-ray examination being performed.*

*Before performing an intraoral radiograph by any Digital X-ray sensor (CMOS or CCD) or Phosphor Plates (PSP), the operator must imperatively verify and eventually adjust the pre-programmed exposure time setting of the Owandy-RX AC using the instructions contained in the accompanying document of the sensor.*

### WARNING

*In radiation physics the X-ray beam intensity is measured in terms of air kerma (mGy), the unit that indicates the amount of radiation in an X-ray beam.*

*The X-ray beam intensity is proportional to the X-ray tube current (mA): doubling the tube current will double the X-ray beam intensity.*

*The X-ray beam intensity is proportional to the exposure time (s): doubling the exposure time will double the X-ray beam intensity.*

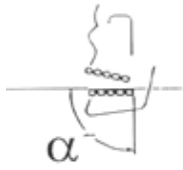

12" LONG CONE (SSD = 31cm)

## CONVENTIONAL RADIOGRAPHIC TECHNIQUE (FILM)

		ADULT																
PROGRAMMED EXPOSURE TIMES (sec)		0,080	0,100	0,125	0,160	0,200	0,250	0,320	0,400	0,500	0,630	0,800	1,000	1,250	1,600		2,000	2,500
FILM D	MAXILLA								I	C P Bp	M	Op						
	MANDIBLE							I	C P	M Ba	-	Oa						
FILM E	MAXILLA						I	C P Bp	M	Op								
	MANDIBLE					I	C P	M Ba	-	Oa								
FILM F	MAXILLA					I	C P Bp	M	Op									
	MANDIBLE				I	C P	M Ba	-	Oa									



		CHILD																
PROGRAMMED EXPOSURE TIMES (sec)		0,080	0,100	0,125	0,160	0,200	0,250	0,320	0,400	0,500	0,630	0,800	1,000	1,250	1,600		2,000	2,500
FILM D	MAXILLA							I	C P Bp	M	Op							
	MANDIBLE						I	C P	M Ba	-	Oa							
FILM E	MAXILLA					I	C P Bp	M	Op									
	MANDIBLE				I	C P	M Ba	-	Oa									
FILM F	MAXILLA				I	C P Bp	M	Op										
	MANDIBLE			I	C P	M Ba	-	Oa										

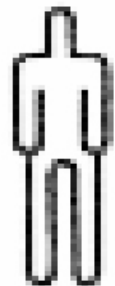

DIGITAL RADIOGRAPHIC TECHNIQUE (SENSOR)

ADULT																	
PROGRAMMED EXPOSURE TIMES (sec)	0,080	0,100	0,125	0,160	0,200	0,250	0,320	0,400	0,500	0,630	0,800	1,000	1,250	1,600	2,000	2,500	3,200
MAXILLA			I	C P Bp	M	Op											
MANDIBLE		I	C P	M Ba	-	Oa											



CHILD																	
PROGRAMMED EXPOSURE TIMES (sec)	0,080	0,100	0,125	0,160	0,200	0,250	0,320	0,400	0,500	0,630	0,800	1,000	1,250	1,600	2,000	2,500	3,200
MAXILLA		I	C P Bp	M	Op												
MANDIBLE	I	C P	M Ba	-	Oa												





8" SHORT CONE (SSD = 20cm)

CONVENTIONAL RADIOGRAPHIC TECHNIQUE (FILM)

ADULT															
PROGRAMMED EXPOSURE TIMES (sec)		0,080	0,100	0,125	0,160	0,200	0,250	0,320	0,400	0,500	0,630	0,800	1,000	1,250	1,600
FILM D	MAXILLA					I	C P Bp	M	Op						
	MANDIBLE				I	C P	M Ba	-	Oa						
FILM E	MAXILLA			I	C P Bp	M	Op								
	MANDIBLE	I	C P	M Ba	-	Oa									
FILM F	MAXILLA	NON DISPONIBILE NOT AVAILABLE													
	MANDIBLE														



CHILD															
PROGRAMMED EXPOSURE TIMES (sec)		0,080	0,100	0,125	0,160	0,200	0,250	0,320	0,400	0,500	0,630	0,800	1,000	1,250	1,600
FILM D	MAXILLA				I	C P Bp	M	Op							
	MANDIBLE			I	C P	M Ba	-	Oa							
FILM E	MAXILLA		I	C P Bp	M	Op									
	MANDIBLE	I	C P	M Ba	-	Oa									
FILM F	MAXILLA	NON DISPONIBILE NOT AVAILABLE													
	MANDIBLE														



DIGITAL RADIOGRAPHIC TECHNIQUE (SENSOR)

ADULT														
PROGRAMMED EXPOSURE TIMES (sec)	0,080	0,100	0,125	0,160	0,200	0,250	0,320	0,400	0,500	0,630	0,800	1,000	1,250	1,600
MAXILLA			I	C P Bp	M	Op								
MANDIBLE		I	C P	M Ba	-	Oa								



CHILD														
PROGRAMMED EXPOSURE TIMES (sec)	0,080	0,100	0,125	0,160	0,200	0,250	0,320	0,400	0,500	0,630	0,800	1,000	1,250	1,600
MAXILLA		I	C P Bp	M	Op									
MANDIBLE	I	C P	M Ba	-	Oa									



# 6

## PROGRAMMING DEFAULT EXPOSURE VALUES

### 6.1. PROGRAMMING DEFAULT EXPOSURE VALUES

**⚠ WARNING**

*The 17 programmed exposure times cannot be modified in the Owandy-RX AC radiographic system. Meanwhile it is possible to customize the default exposure values.*

**⚠ WARNING**

*After customizing, the “Chart of default exposure values” (refer to Chapter 5) are not valid any more.*

To program the new exposure values press the following keys

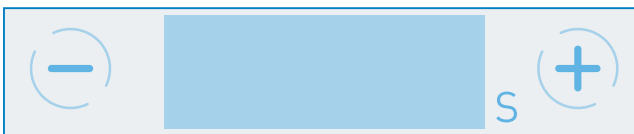

**📌 PLEASE NOTE**

*The “repeat” function automatically sets in when the key is kept pressed, so the time shown on the display scrolls faster.*

To confirm the new program check the LED key

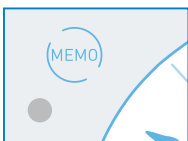

**LED MEMO ON**

indicates that it is possible to save the new default exposure value.  
Press the button for 3s until the acoustic signal confirms the new default exposure values have been saved.

**LED MEMO OFF**

indicates that it is not possible to save the new default exposure value

**📌 PLEASE NOTE**

**It is not possible to save data when the “range of exposure field” exceeds the programmed exposure time limits. (refer to the example in the next page)**



**EXAMPLE**

**12" LONG CONE (SSD = 31cm)  
CONVENTIONAL RADIOGRAPHIC TECHNIQUE (FILM)**

**PREDEFINED DEFAULT EXPOSURE VALUES**

		ADULT																
PROGRAMMED EXPOSURE TIMES (sec)		0,080	0,100	0,125	0,160	0,200	0,250	0,320	0,400	0,500	0,630	0,800	1,000	1,250	1,600		2,000	2,500
FILM D	MAXILLA								I	C P Bp	M	Op						
	MANDIBLE							I	C P	M Ba	-	Oa						
FILM E	MAXILLA						I	C P Bp	M	Op								
	MANDIBLE					I	C P	M Ba	-	Oa								
FILM F	MAXILLA					I	C P Bp	M	Op									
	MANDIBLE				I	C P	M Ba	-	Oa									

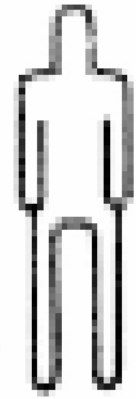

**CUSTOMISED EXPOSURE VALUES**

THE RANGE OF EXPOSURE FIELD HAS BEEN REDUCED BY TWO STEPS

	I	C P Bp	M	Op
I	C P	M Ba	-	Oa

		ADULT																
PROGRAMMED EXPOSURE TIMES (sec)		0,080	0,100	0,125	0,160	0,200	0,250	0,320	0,400	0,500	0,630	0,800	1,000	1,250	1,600		2,000	2,500
FILM D	MAXILLA						I	C P Bp	M	Op								
	MANDIBLE					I	C P	M Ba	-	Oa								
FILM E	MAXILLA				I	C P Bp	M	Op										
	MANDIBLE			I	C P	M Ba	-	Oa										
FILM F	MAXILLA			I	C P Bp	M	Op											
	MANDIBLE		I	C P	M Ba	-	Oa											

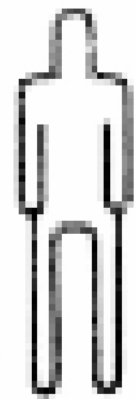

## 6.2. RESTORING ORIGINAL VALUES



1 . Turn off the timer

2. Turn the timer on keeping the key pressed **MEMO**



3 . “OFF” appears on the display



4. Release the key

5. Press again the key **MEMO**

6 . “ON” appears on the display

7 . Turn off and on the timer

# 7 DIAGNOSTIC

## 7.1. DIAGNOSTIC

With **Owandy-RX AC** radiographic system it is possible to set and visualise certain functional parameters.





To visualise them proceed as follows:

1. press simultaneously and keep pressed the keys

(17) MAXILLA MOLAR

(47) MANDIBULARY MOLAR

2. press the key associated to the parameter one wishes to visualise

KEY	DISPLAY PARAMETER
	RADIOGRAPHIC SYSTEM NOMINAL VOLTAGE
	LINE VOLTAGE
	MAXIMUM LINE VOLTAGE VALUE DETECTED
	MINIMUM LINE VOLTAGE VALUE DETECTED
	SOFTWARE VERSION

# 8 CHAPTER 8

## 8.1. ERROR MESSAGES

An anomaly is indicated as follows:

- emission of an intermittent acoustic signal (beep)
- MALFUNCTIONING INDICATOR LED intermittently turns on
- the error code (E ....) appears on the display)
- all control panel functions are inhibited

In this case turn off the timer and then turn it back on. If the error persists, refer to the following table.

The following chart gives a list of error messages that may appear while **Owandy-RX AC** radiographic system is working.

The chart also includes the causes of the error messages to be communicated to the technical support and, in some cases, what to do to solve them.

If the error is not fixed by carrying out the described solution, turn off the power supply from the electrical panel (wall mounting version) or unplug the system (mobile version)

ERROR MESSAGES	CAUSE	SOLUTION
<b>E00</b>	RX1 TUBEHEAD IS NOT CONNECTED OR IS OUT OF ORDER	CALL THE "ASSISTANCE SERVICE"
<b>E01</b>	RX2 TUBEHEAD IS NOT CONNECTED OR IS OUT OF ORDER	CALL THE "ASSISTANCE SERVICE"
<b>E02</b>	CORRUPTED EEPROM DATA	CALL THE "ASSISTANCE SERVICE"
<b>E03</b>	EEPROM DATA NOT SAVED PROPERLY	CALL THE "ASSISTANCE SERVICE"
<b>E07</b>	LINE VOLTAGE VALUE NOT INCLUDED WITHIN THE NOMINAL VALUE	CALL THE "ASSISTANCE SERVICE"
<b>E08</b>	THE X-ray KEY ALWAYS SEEMS TO BE PRESSED	MAKE SURE IT IS NOT JAMMED
<b>E09</b>	ANOMALY IN THE CONTROL PANEL	CALL THE "ASSISTANCE SERVICE"
<b>E12</b>	THE EXPOSURE HAS BEEN PREMATURELY INTERRUPTED	KEEP THE X-ray KEY PRESSED TILL THE END OF THE EXPOSURE
<b>E20</b>	ANOMALY IN THE TRIAC/RELAY	CALL THE "ASSISTANCE SERVICE"
<b>E21</b>	ANOMALY IN THE ELECTRONIC CIRCUIT	CALL THE "ASSISTANCE SERVICE"
<b>E22</b>	ANOMALY IN THE CONTROL CIRCUIT	CALL THE "ASSISTANCE SERVICE"
<b>E23</b>	INCORRECT DIP-SWITCH CONFIGURATION	CALL THE "ASSISTANCE SERVICE"
<b>E24</b>	THE CONTROL BUTTON DOES NOT CORRESPOND TO THE SELECTED TUBEHEAD	CALL THE "ASSISTANCE SERVICE"
<b>ERR</b>	MAJOR ERROR	ALL FUNCTIONS ARE DISABLED CALL THE "ASSISTANCE SERVICE"

# 9

## VERIFICATION OF THE EXPOSURE FACTORS

### 9.1. VERIFICATION OF THE EXPOSURE FACTORS

In order to guarantee safety of the radiographic system, it is necessary to set up a periodic control schedule of the exposure factors.

The RESPONSIBLE ORGANIZATION is required to organise and observe a control schedule of the exposure factors as detailed in this chapter.

All the following controls must be performed every 12 months.

#### ⚠ CAUTION

*During these procedures X-rays will be emitted. Please take every necessary precautions in order to avoid accidental exposure to ionizing radiations.*

#### **STEP 1 – Checking the radiographic voltage (kVp)**

The radiographic voltage is measured using a calibrated “non invasive” instrument.

##### SET TECHNICAL FACTORS

Vn ± 10%	NOMINAL VOLTAGE
3%	MAXIMUM VOLTAGE DROP
70 kV	NOMINAL HIGH VOLTAGE
8 mA	NOMINAL CURRENT
3,2 s	SET EXPOSURE TIME

The radiographic voltage is 70kVp ±10%.

#### **STEP 2 – Dose verification (mGy)**

The dose in air is measured with a “non invasive” instrument, by positioning the detector at a source-skin distance = 31cm (12”) (SSD) or 20cm (8”) (SSD).

##### SET TECHNICAL FACTORS

Vn ± 10%	NOMINAL VOLTAGE
3%	MAXIMUM VOLTAGE DROP
70 kV	NOMINAL HIGH VOLTAGE
8 mA	NOMINAL CURRENT
1 s	SET EXPOSURE TIME

Dose in air is:

SOURCE-SKIN DISTANCE

31 cm = 12"	20 cm = 8"
70 kV – 8 mA = 5,5 mGy/s ± 30%	70 kV – 8 mA = 12 mGy/s ± 30%

**STEP 3 – Checking the exposure time (s)**

The exposure time is measured with a “non invasive” instrument.

SET TECHNICAL FACTORS

Vn ± 10%	NOMINAL VOLTAGE
3%	MAXIMUM VOLTAGE DROP
70 kV	NOMINAL HIGH VOLTAGE
8 mA	NOMINAL CURRENT
3,2 s	SET EXPOSURE TIME

The exposure time measured is 3,2s ±5% or ±20 ms, whichever is larger.

# 10

## SUGGESTED MAINTENANCE

### 10.1. SUGGESTED MAINTENANCE

In order to guarantee safety of the radiographic system, it is necessary to set up a maintenance schedule. The RESPONSIBLE ORGANISATION is responsible for planning and observing a maintenance schedule which must be executed by qualified technicians who must be able to certify their work with a “Conformity Declaration”.

#### CAUTION

*Run an inspection on the radiographic system and on its operation when it is installed and every twelve months.*

Once a year, lubricate the pins and bushes of the wall plate and the positioning arm, as specified in the INSTALLATION & MAINTENANCE MANUAL.

#### WARNING

*Do not lose the adjustment key that comes with the system, since, in time, it could become necessary to make readjustments.*

#### WARNING

*If the parts should become hard to move or should squeak, call the “Assistance Service”.*

### 10.2. CLEANING THE OUTER SURFACES

Clean the external surface using a damp cloth and non-corrosive non oil-based detergent and disinfect it using a non-aggressive medical detergent.

Do not spray detergent or disinfectant directly on the device.

The spacer cone may be cleaned with cotton wool soaked with surgical alcohol.

#### CAUTION

- *Turn off and disconnect the device from the supply mains before carrying out cleaning operations.*
- *Do not spray products directly on the device. Apply the product on a clean cloth.*
- *Always use disposable protective covers for the applied parts.*
- *Do not use UV systems to disinfect the equipment, as exposed parts of the device can turn yellow or discolour.*
- *To avoid any potential hazard or danger to operators and patients, contact your authorized Owandy Radiology Technical Representative immediately if you experience any unusual operation, mechanical issues, or equipment malfunction.*

**⚠ CAUTION**

- *To ensure both the patient's and operator's safety as well as preserving a high image quality, the device must always be well maintained as described in the accompanying documents. For other maintenance operations, refer to the installation and maintenance manual.*
- *The RESPONSIBLE ORGANIZATION of the device is responsible for scheduling and having preventive maintenance carried out at least every 12 (twelve) months, which consists of maintenance carried out by qualified, authorized professional technicians. It is the RESPONSIBLE ORGANIZATION'S responsibility to arrange for this service and to assure that the personnel performing this function are fully qualified to service Owandy-RX AC X-ray equipment.*
- *The RESPONSIBLE ORGANIZATION must always carry out routine maintenance on a daily basis to ensure optimal device performance. These checks must be performed to complete the installation of the Owandy-RX AC X-ray System and as part of the recommended maintenance as indicated in the accompanying documents. Failure to perform these checks may result in an installation that does not comply with U.S. Radiation Performance Standards 21 CFR Subchapter J.*
- *The manufacturer shall not be held liable for damage or injuries caused by failure to carry out inspections and tests and by incomplete maintenance.*
- *Repairs and replacements of any component must be carried out solely by authorized and highly qualified personnel and only using genuine spare parts supplied by Owandy Radiology.*
- *Do not operate the unit if there is the threat of an earthquake. Following an earthquake, ensure that the unit is operating properly. It's mandatory to thoroughly check all functions and safety aspects before resuming use.*



# 11 REPAIR

## 11.1. REPAIR

In case of a malfunction, send the defective part following specific instructions provided by the technical support or using the original packaging to:

### Owandy Radiology

2 rue des Vieilles Vignes  
77183 Croissy-Beaubourg  
FRANCE

Tel. +33 1 64 11 18 18  
info@owandy.com

### CAUTION

*It is strictly prohibited to attempt repairs to any electronic or mechanical parts by yourself.  
Failure to observe this warning can irreversibly compromise the overall safety of the system and can be dangerous for operators, patients and the environment.*

## 11.2. DISPOSAL



The use of the WEEE symbol  indicates that, at the end of its lifespan, this product may not be treated as household waste, but must be treated separately, in conformity to the Directive 2012/19/EC.

EU Council Directive 2012/19/EC (WEEE) imposes the disposal or recycling of electric and electronic equipment. The product is marked with the indicated icon. This product must not be disposed of as domestic waste. The crossed-out wheeled bin identifies a product placed on the market after the 13th of August 2005 (see EN 50419:2006). This product is subjected to Council Directive 2012/19/EU (WEEE) and implementation standards in force in your country.

The product must be disposed of or recycled to protect the environment.

Contact your supplier before disposing of this product.

### CAUTION

*To avoid any risk of environmental contamination, do not dispose the device and its accessories together with the domestic waste.*

# A1 ANNEX 1

## A1. TECHNICAL SPECIFICATIONS

### X-ray SOURCE ASSEMBLY

Half Value Layer (HVL) at 70 kV	2 mm Al
Total filtration at 70 kV	2,3 mm Al
Tube inherent filtration at 70 kV	> 1 mm Al
X-ray tube tension accuracy	±10%
X-ray tube current accuracy	±20%
Radiation linearity	±10%
X-ray emission time accuracy	±20 ms 0,020 s ≤ t ≤ 0,320 s ±5% 0,400 s ≤ t ≤ 3,2 s
Reproducibility	0,05
Generator	Single phase X-ray generator
X-ray tube nominal current	8 mA
X-ray tube nominal voltage	70 kV
Exposure times	0,080 s ÷ 3,2 s (17 steps)
Reference current-time product	0,8 mAs 8 mA 0,1 s
Intensity of radiation in the air	> 30 µGy/h at 1 m from focal spot
Leakage radiation (measured @ 70kV, 8 mA, 3,2 s)	< 0,25 mGy/h at 1 m from focal spot
Operating cycle	1:32
Loading factors related to the maximum specified energy input in one hour	70kV – 8mA

#### PLEASE NOTE

*The measurements criteria are based on the requirements stated by the applicable standards listed in the annex A.3 of this manual.*

HEATING AND COOLING CURVES

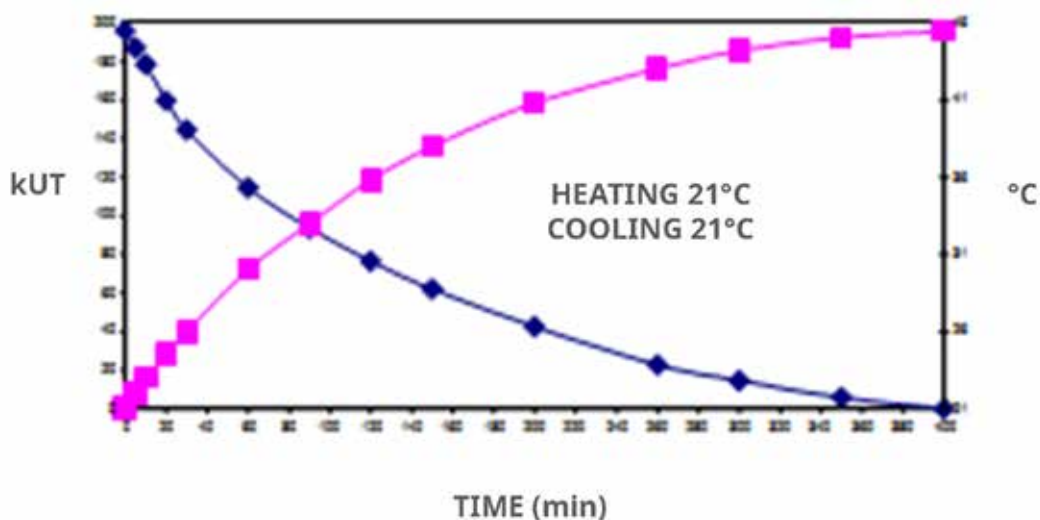

**X-ray TUBE**

X-ray tube model	CEI OX70-G7	TOSHIBA DG-073-AC
Focal spot size (IEC 336)	0,7 mm	0,7 mm
Anode angle	16°	20°
Anod material	tungsten	tungsten

Heating/cooling curves

Anode Heating / Cooling Curve

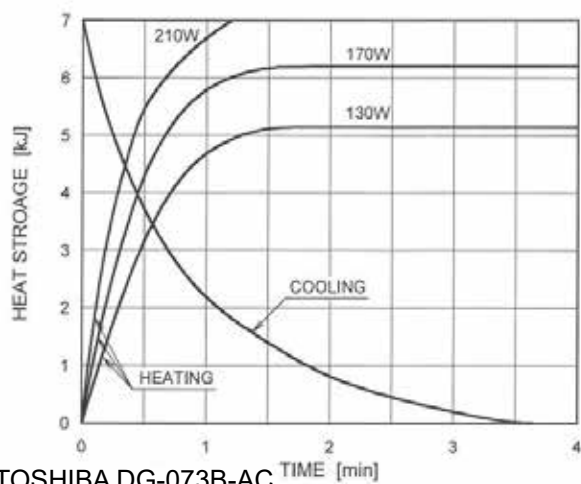

TOSHIBA DG-073B-AC

THERMAL CURVES

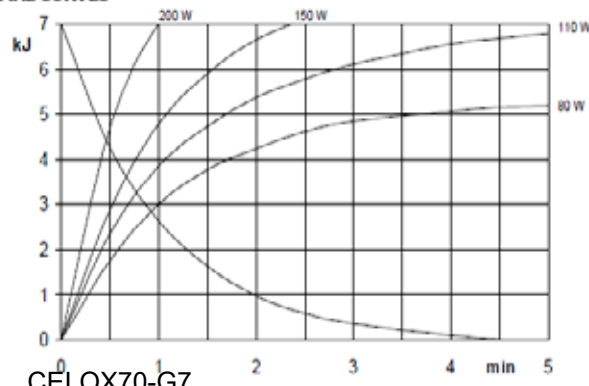

CEI OX70-G7

### **DEVICE POWER SUPPLY**

Type of power supply	single phase, alternate
Supply nominal voltage	115 V / 220V / 230V
Maximum voltage variation	±10%
Nominal current	3,5 A @ 220V / 230V 5,7 A @ 115V
Supply voltage frequency	50/60 Hz
Maximum line current (measured @ 70 kV, 8 mA, 3,2 s)	5,7 A @ 115V
Absorbed power	0,8 kVA at 230V 0,79 kVA at 220V 0,66 kVA at 115V
Apparent resistance	0,5 Ω at 220V / 230V 0,2 Ω at 115V
Protection fuses (F1 – F2 – F3 – F4)	F 8 A – 250 V at 220V / 230V F 12,5 A – 250 V at 115V
Circuit protection fuses	(F5) – n° 1 630 mA – 125 V (F6) – n° 1 500 mA – 125 V

### **ELECTRICAL CLASSIFICATION (IEC 60601-1)**

Protection against electrical shock (insulation class)	Class I
Degree of protection against electrical Shock (applied part)	Type B (collimator cone)
Protection against harmful ingress of water or particulate matter	IP 20
Use with flammable anaesthetics	Not for use in presence of flammable anaesthetic mixture with air, oxygen or nitrous oxide.
Sterilization and disinfection methods	The device is supplied not sterile and it must not be subjected to sterilization
Operation mode	Continuous operation with intermittent X-ray loading

### **MECHANICAL DATA**

Total weight	19,5 kg (wall mounting) 50 kg (mobile version)
Weight of the tubehead	5,5 kg
Mechanical configuration	Wall mounting, top and bottom / Mobile

**COLLIMATOR CONE TECHNICAL DATA**

Source-skin distance (SSD)	short cone long cone rectangular cone	20 cm (8") 31 cm (12") 31 cm (12")
X-ray beam dimension	short cone long cone rectangular cone	≤ 60 mm ≤ 60 mm 44x35 mm

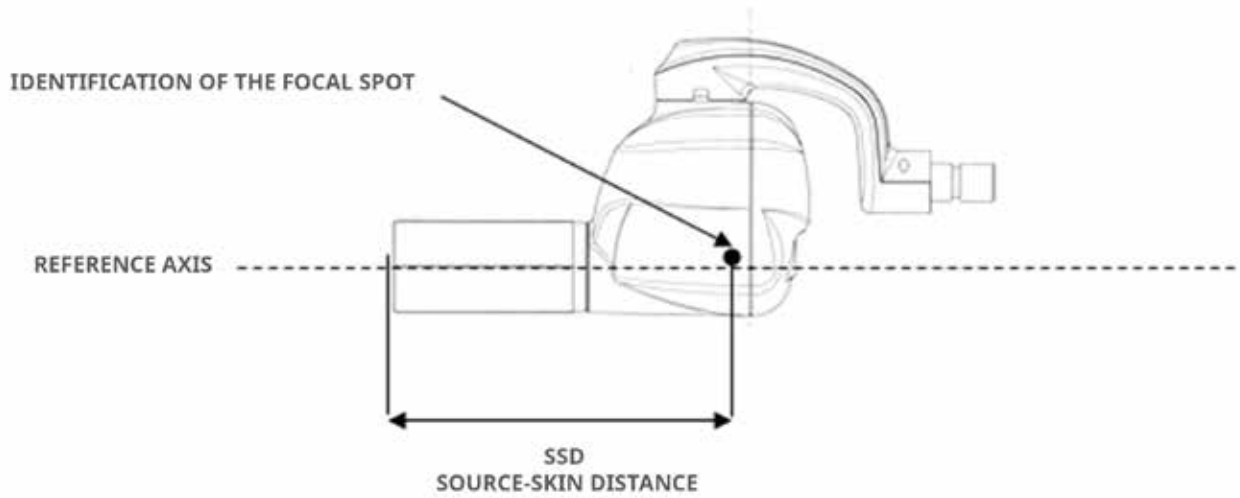

# A2

## ANNEX 2

### A2. INTENDED ENVIRONMENT

#### ⚠ CAUTION

*Owandy-RX AC is for INDOOR USE ONLY.*

*If the Owandy-RX AC has been stored at a temperature below +10°C (+50° F) for more than a few hours, enough time must be allowed for the device to reach the room temperature before reconnecting it to the mains voltage and applying power.*

### CLINICAL ENVIRONMENT CONDITIONS (OPERATING CONDITIONS)

- Temperature: 10 °C (50°F) ÷ 40 °C (104°F);
- Relative humidity: 25 ÷ 75 %;
- Atmospheric pressure: 850 ÷ 1060 hPa.

### TRANSPORTATION ENVIRONMENT CONDITIONS

- Temperature: 0 °C (32°F) ÷ 50 °C (122°F);
- Relative humidity: see clinical environment conditions
- Atmospheric pressure: 500 ÷ 1060 hPa

### WAREHOUSE ENVIRONMENT CONDITIONS

- Temperature: -15 °C (5°F) ÷ 50 °C (122°F);
- Relative humidity: see clinical environment conditions
- Atmospheric pressure: 500 ÷ 1060 hPa

# A3 ANNEX 3

## A3. LIST OF INTERNATIONAL STANDARDS AND DIRECTIVES

**Owandy-RX AC:** X-ray equipment for dental intraoral radiography is classified as:

Directive	MDD 93/42 EEC Annex IX, article 10	TG(MD) Regulations 2002 Schedule 2 part 4.3
Class	IIb	IIb

- IEC/EN 60601-1:2005 + A1:2012 (3.1 edition)
- IEC/EN 60601-1-3:2008 + A1:2013 (2.1 edition)
- IEC/EN 60601-1-6:2010 + A1:2013 (3.1 edition)
- IEC 62366: 2007
- IEC 60601-2-65:2012 A1:2017 (1.1 edition)
- IEC/EN 60601-1-2: 2014 (4 edition)
- IEC 62304:2006 + A1:2015



# A4 ANNEX 4

## A4. DOSIMETRIC INDICATIONS

The radiation exposure is reported in terms of Dose Area Product (DAP), which takes into account the entire area of the X-ray beam and the total amount of X-ray radiation incident on the patient. The DAP is obtained by multiplying the Air Kerma by the corresponding X-ray beam area, which is dependent by the typology of beam limiting device installed. It is independent by the measured location, because increases in beam area are compensated by the reduction of beam intensity (inverse square law).

The dosimetric values reported here are relevant to the following measured values of Total Filtration and Half Value Layer (HVL):

kV	HVL (mm Al)	Total Filtration (mm Al)
70	2,0	2,3

In the following tables the radiation exposure is indicated in terms of DAP [mGy cm<sup>2</sup>] for each setting of kV, beam limiting device length (SSD) and Beam Limiting Device type (circular or rectangular).

As per paragraph 203.6.4.5 of the IEC 60601- 2-65, the overall deviation from the estimated air kerma is within 50%.

Cone type	Circular Long	Short Circular	Rectangular Long
SSD (mm)	310	200	310
kV	70	70	70
mA	8	8	8
Time (s)	DAP (mGy*cm <sup>2</sup> )	DAP (mGy*cm <sup>2</sup> )	DAP (mGy*cm <sup>2</sup> )
0,08	5,559	13,597	3,458
0,1	6,949	16,996	4,323
0,125	8,686	21,246	5,403
0,16	11,118	27,194	6,916
0,2	13,897	33,993	8,646
0,25	17,372	42,491	10,807
0,32	22,236	54,388	13,833
0,4	27,795	67,986	17,291
0,5	34,744	84,982	21,614
0,63	43,777	107,077	27,234
0,8	55,590	135,971	34,582
1	69,487	169,964	43,228
1,25	86,859	212,455	54,035
1,6	111,179	271,942	69,165
2	138,974	339,928	86,456
2,5	173,718	424,910	108,070
3,2	222,358	543,885	138,329



# A5 ANNEX 5

## A5. ELECTROMAGNETIC COMPATIBILITY

Electromagnetic compatibility (EMC) is assessed with reference to the following standards:

IEC/EN 60601-1-2: 2014 (4 edition)

### EMISSION

- CEI EN 55011: 2013
- CEI EN 61000-3-2: 2015
- CEI EN 61000-3-3: 2014

### IMMUNITY

- CEI EN 61000-4-2: 2011
- CEI EN 61000-4-3: 2007 + A1: 2008
- CEI EN 61000-4-4: 2013
- CEI EN 61000-4-5: 2007
- CEI EN 61000-4-6: 2011
- CEI EN 61000-4-8: 2013
- CEI EN 61000-4-11:2006

<b>Guidance and manufacturer's declaration – electromagnetic emissions</b>		
<p><b>Owandy-RX AC</b> is intended to be used in the electromagnetic environment specified below. The customer or the operator of <b>Owandy-RX AC</b> must ensure that the device is used in this type of environment.</p>		
Emission test	Conformity	Electromagnetic environment guidance
RF emissions <b>CISPR 11</b>	Group 1	Owandy-RX AC uses RF energy only for internal operation. RF emissions are extremely and attenuated are not likely to generate interference with electronic equipment in the vicinity.
RF emissions <b>CISPR 11</b>	Class B	
Harmonic emissions <b>CEI EN 61000-3-2</b>	Class A	
Voltage fluctuations/flicker emissions <b>CEI EN 61000-3-3</b>	Complies	
<p><b>NOTE:</b> Ensure that the device is not stack and location close to other EQUIPMENT please refer to the «<b>Recommended separation distances between portable and mobile RF communication equipment and Owandy-RX AC medical device</b>»</p>		

<b>Guidance and manufacturer's declaration – electromagnetic immunity</b>			
<p><b>Owandy-RX AC</b> is intended to be used in the electromagnetic environment specified below.            The customer or <b>Owandy-RX AC</b> operator must ensure that the device is used in this type of environment.</p>			
<b>Immunity test</b>	<b>CEI EN 60601 test level</b>	<b>Compliance level</b>	<b>Electromagnetic environment guidance</b>
Electrostatic discharge (ESD) <b>CEI EN 61000-4-2</b>	+/- 8 kV contact +/- 15 kV air	CEI EN 60601-1-2 Test level	Floors should be wood, concrete or ceramic tile. If floors are covered with synthetic material, the relative humidity must be at least 30%
Electrical fast transient/burst <b>CEI EN 61000-4-4</b>	+/- 2 kV for power supply lines +/- 1 kV for input/output lines	CEI EN 60601-1-2 Test level	Mains power quality should conform to that of typical commercial or hospital applications.
Surge <b>CEI EN 61000-4-5</b>	+/- 1 kV differential mode +/- 2 kV common mode	CEI EN 60601-1-2 Test level	Mains power quality should conform to that of typical commercial or hospital applications.
Voltage dips, short interruptions and voltage variations on power supply input lines <b>CEI EN 61000-4-11</b>	<5 % UT for 0.5 cycles (>95 % dip in UT)  40 % UT for 5 cycles (60 % dip in UT)  70 % $U_T$ (30 % dip in $U_T$ ) for 25 cycles (50Hz) for 30 cycles (60Hz)  <5 % UT for 5 onds (>95 % dip in UT)	CEI EN 60601-1-2 Test level	Mains power quality should conform to that of typical commercial or hospital applications. If the Owandy-RX AC operator requires continued operation even during mains power outage, we recommend powering the system using a UPS.
Mains frequency (50/60 Hz) magnetic field <b>CEI EN 61000-4-8</b>	30 A/m	CEI EN 60601-1-2 Test level	Power frequency magnetic fields must be at the typical level of standard mains for commercial or hospital use.
<p>Note: <math>U_t</math> is the AC mains voltage prior to the application of the test level.</p>			

<b>Guidance and manufacturer's declaration – electromagnetic immunity</b>
---

Owandy-RX AC is intended to be used in the electromagnetic environment specified below. The customer or Owandy-RX AC operator must ensure that the device is used in this type of environment.

Immunity test	CEI EN 60601 test level	Compliance level	Electromagnetic environment guidance
---------------	-------------------------	------------------	--------------------------------------

**⚠ CAUTION**  
 Portable and mobile RF communication equipment should be used no closer than 30 cm (12 inches) to any part of the Owandy-RX AC, including cables than the recommended separation distance, calculated according to the equation corresponding to the frequency of the transmitter.

Conducted RF <b>CEI EN 61000-4-6</b>	3 Vrms 150 kHz to 80 MHz 6 V RMS in the ISM (Industrial, Scientific and Medical) band	3 Vrms	Recommended separation distance $d = 1,2 \sqrt{P}$
---	---	--------	---

Radiated RF <b>CEI EN 61000-4-3</b>	10 V/m 80MHz to 2.5GHz	3 V/m	$d = 1,2 \sqrt{P}$ 80 MHz - 800 MHz $d = 2,3 \sqrt{P}$ 800 MHz - 2.5 GHz  where P is the maximum output power rating of the transmitter in watts (W) according to the transmitter manufacturer and “d” is the recommended separation distance in metres (m). Field strength from fixed RF transmitters as determined by an electromagnetic site survey <sup>a</sup> must be below the compliance level corresponding to each frequency range. <sup>b</sup> Interference can occur in the proximity of equipment marked with the following symbol :  
--	---------------------------	-------	---

Notes:  
 • At 80 MHz and 800 MHz the higher frequency range applies.  
 • These guidelines may not apply in every situation. Electromagnetic propagation is affected by absorption and reflection from structures, objects and people.

a - Field strength from fixed RF transmitters, such as base stations for radio (cellular/wireless) telephones and land mobile radios, amateur radio, AM and FM radio and TV broadcast cannot be predicted with accuracy on a theoretical basis. To assess the electromagnetic environment created by fixed RF transmitters, an electromagnetic site survey should be considered. If the measured field strength in the place where the equipment is used exceeds the corresponding RF compliance level (see above), it is important to ensure regular equipment operation. In the event of abnormal operation, additional measures may be required, such as redirecting or relocating Owandy-RX AC.  
 b - Over the frequency range between 150 kHz and 80 MHz, the field strength must be below 10 V/m.

**Recommended separation distances between portable and mobile RF communication equipment and Owandy-RX AC medical device**

These devices are intended to be used in environments where radiated RF interference is controlled. The customer or Owandy-RX AC operator can help prevent electromagnetic interference by maintaining a minimum distance between portable and mobile RF communication equipment (transmitters) and Owandy-RX AC, as indicated below, according to the maximum output power of the communication equipment.

Rated maximum output power of the transmitter [W]	Separation distance according to transmitter frequency [m]		
	150 kHz - 80 MHz $d = 1,2 \sqrt{P}$	80 MHz - 800 MHz $d = 1,2 \sqrt{P}$	800 MHz - 2.5 GHz $d = 2,3 \sqrt{P}$
0.01	0.12	0.12	0.24
0.1	0.38	0.38	0.73
1	1.2	1.2	2.3
10	3.8	3.8	7.3
100	12	12	23

In the event of transmitters whose maximum nominal output power coefficient does not fall within the indicated parameters, the recommended separation distance in metres (m) can be determined by means of the equation corresponding to the frequency of the transmitter, where P is the maximum output power coefficient of the transmitter in watts (W) according to the information provided by the manufacturer.

Note 1: At 80 MHz and 800 MHz apply the separation distance corresponding to the highest frequency range.

Note 2: These guidelines may not apply in every situation. Electromagnetic propagation is affected by absorption and reflection from structures, objects and people.

**⚠ CAUTION**

Pay attention to take any precautions to be taken to prevent adverse events to the PATIENT and Operator due to electromagnetic disturbances.

# A6 ANNEX 6

## A6. DRAWINGS AND DIMENSIONS

### WALL INSTALLATION

Lateral view (rest position)  
Bottom mount

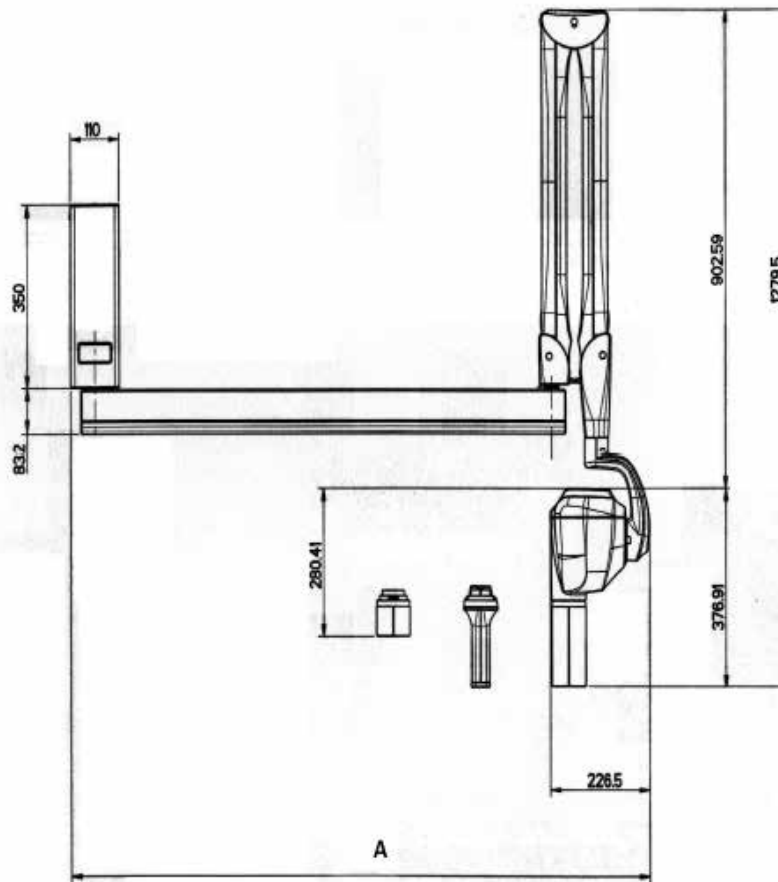

A	
40 cm (16") bracket	63 cm
80 cm (31") bracket	104 cm
110 cm (43") bracket	132 cm

**Lateral view (open)  
Bottom mount**

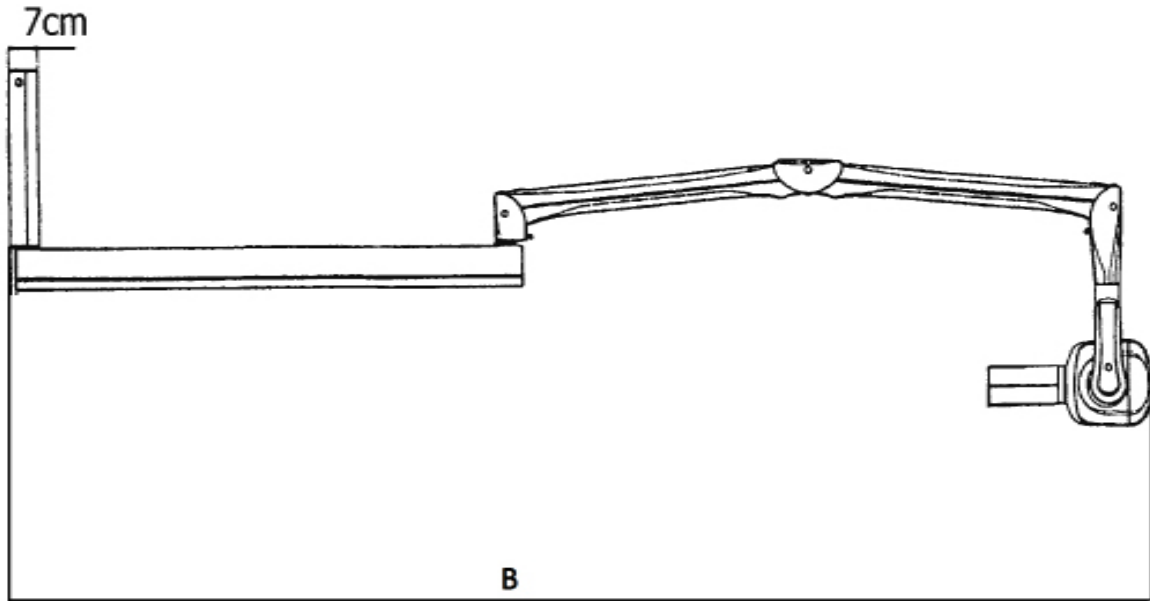

<b>B</b>	
40 cm (16") bracket	178 cm
80 cm (31") bracket	220 cm
110 cm (43") bracket	247 cm

The system can also be mounted with the timer on the top. For details, refer to the Installation and Maintenance Manual.

**MOBILE INSTALLATION**

Owandy-RX AC exists also in the mobile version and it is sustained by the stand shown in the following figure:

*Only for the mobile version of Owandy-RX AC*

*It is allowed to connect the equipment to the main supply using a plug supplied by the manufacturer.*

**⚠ CAUTION**

*Repairs and replacements of any component included cables, must be carried out solely by authorized and highly qualified personnel and only using genuine spare parts supplied by Owandy Radiology. using other cables may negatively affect EMC performance.*

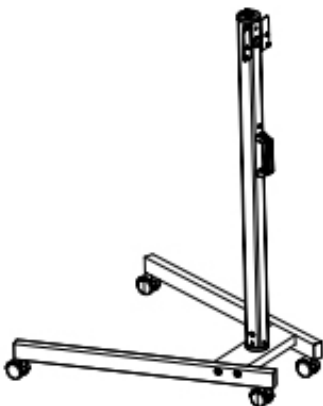

For details, refer to the Mobile Unit Technical Note, supplied with this structure.

# A7 ANNEX 7

## A7. INSTALLATION ELECTRICAL SCHEME

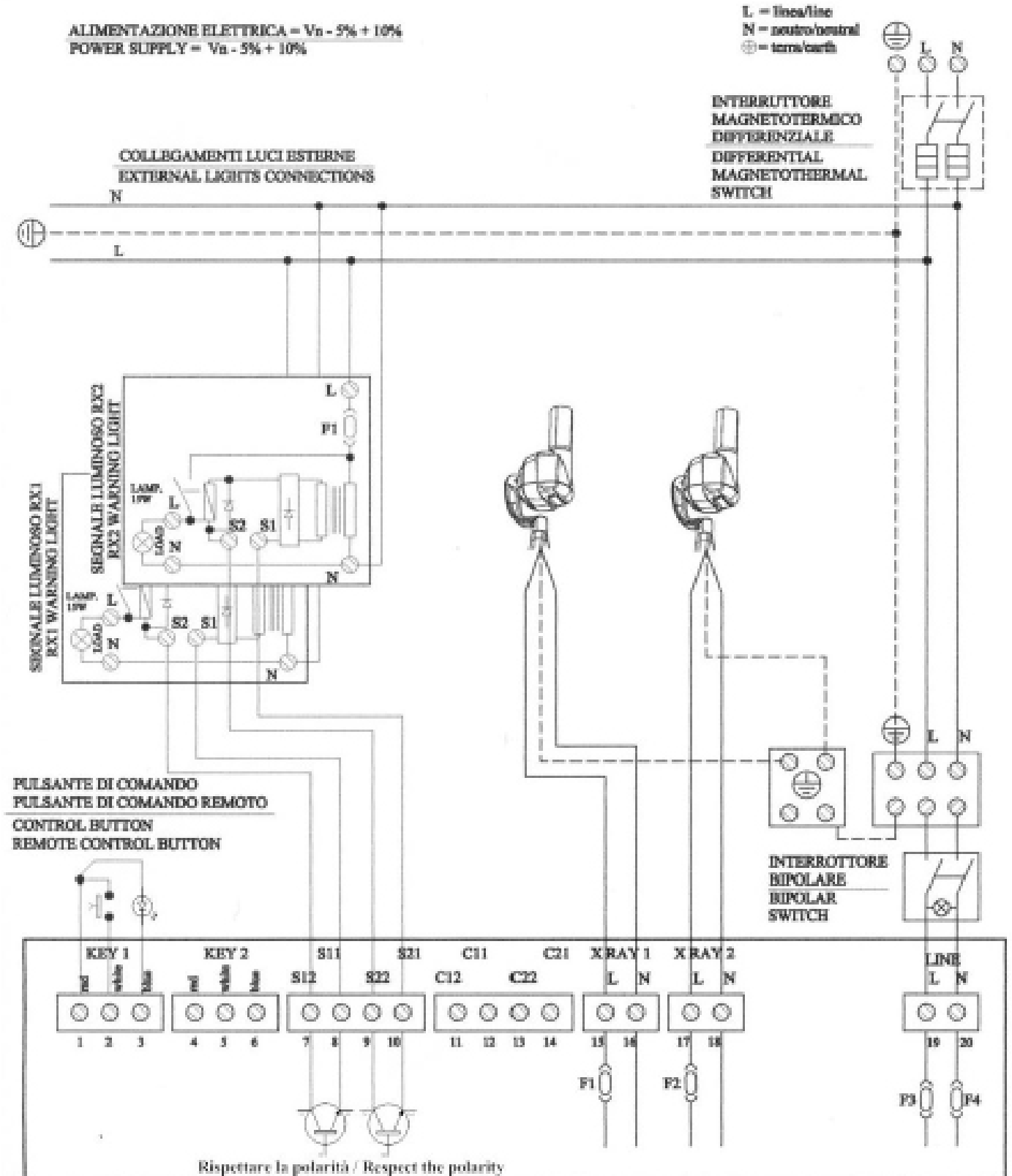

# DIGITAL WORKFLOW OWANDY RADIOLOGY

A COMPREHENSIVE RANGE TO MEET ALL YOUR REQUIREMENTS

